

Modeling of Wind Energy Conversion System Including DFIG for Distributed Generation Studies

S. Ghassem Zadeh¹

S. H. Hosseini²

G.B. Gharehpetian³

1- PhD Student, Faculty of Electrical and Computer Engineering, University of Tabriz, Tabriz, Iran

2- Professor, Faculty of Electrical and Computer Engineering, University of Tabriz, Tabriz, Iran

3- Professor, Electrical Engineering Department, Amirkabir University of Technology, Tehran, Iran

Abstract:

A detailed model of wind power station, including Double Fed Induction Generator, DFIG is presented in this paper. Two control mechanisms are included in the model. The inner control system uses stator flux oriented control for the rotor side converter and grid voltage vector control for the grid side converter. The outer control system is used for wind turbine pitch angle. PSCAD/EMTDC is used for the simulation. The simulation model is used to investigate the performance of controllers under wind speed variations, short circuit at the grid side and dynamics of active power demand.

Keywords: Distributed generation, Wind energy conversion system, DFIG

Submission date: Dec. 02, 2008

Acceptance date: Dec. 11, 2010

Corresponding author: S. Ghassem Zadeh

Corresponding author's address: Faculty of Electrical and Computer Engineering, University of Tabriz, Tabriz, Iran

1. Introduction

The increasing electricity generation from renewable resources and introduction of distributed generation into distribution systems significantly complicate distribution operating and require substantially greater analysis efforts. It is estimated that by 2010, 25-30% of new generation will be distributed and 60% of renewable resources will be utilized as DG [1]. Unlike traditional power systems, the distributed generation technologies are so various inherently and so numerous [2,3,4]. From the viewpoint of the power generation, renewable resources, as a function of time are some what unpredictable, intermittent and uncontrollable. On the other hand a high penetration of DG in the distribution network may cause power flow to reverse from distribution to the transmission grid. A DG with a renewable recourse is usually connected to the distribution grid by a power converter. These all means that there could hardly be a general method of analysis for the power systems in the presence of distributed generation and renewable resources and each configuration should be studied individually [5, 6 and 7].

This paper investigates the dynamic behavior of grid connected DFIG in a DG shape environment. For this purpose a complete wind power station, including wind turbine, wind turbine governor, wind resources and the DFIG is analyzed. Then detailed model of DFIG is presented. It consists of wound rotor induction machine, grid side converter, rotor side converter and associated controllers. The control scheme uses stator flux oriented control for the rotor side converter and grid voltage vector control for the grid side converter. The main power electronic circuits and controllers are also developed in details and in the same simulation tool. The simulation model is also used to investigate the performance of the WECS under different network conditions.

Power system is studied in a distributed generation configuration. DFIG is coupled to the power grid via a main transformer. Complete studies is performed for variable wind conditions, control of active and reactive powers, the performance of DFIG under fault conditions and the interaction between DFIG and power system under variable loads. Simulation studies for wind variation includes gust component in wind. The responses of rotor speed, active power output, blade pitch angle, DC voltage of the grid side converter, rotor and stator currents are obtained for various conditions of power grid.

While this study shows the performance of a wind power station in variable wind and power grid conditions, it is an essential and preliminary part of investigating the integrating issues of renewable distributed generation with power grid.

2. Modeling of Wind Energy Conversion System

Modeling and control of WECS has well been discussed in the literature [9, 10, 11 and 12]. It usually consists of: wind source, turbine aerodynamics, turbine shaft and a gearbox, generator, power electronic converter and control system. Wind source is used to generate several wind conditions, including wind mean speed, wind ramp, wind gust and wind noise. A horizontal 3 blade, pitch controlled wind turbine with a wind governor is used to acquire the desired power coefficient, C_p .

2.1. Generator

Among the several configurations of wind energy conversion systems, the concept of Double Fed Induction Generator, DFIG, has gained so much attention. This configuration is shown in Fig. 1. The theory and analysis of DFIG has well been discussed in the literature [8, 11, 13, 14, 15 and 16]. A frequency converter controls the current in the rotor winding; this enables a decoupled power control of the machine with a constant frequency in the variable wind speed. The power electronic converter is usually at 20-30% of nominal generator power, an advantage compared to other variable speed WECS [8]. It is shown that the wind turbine market trend is toward application of this configuration due to its inherent compatibility with wind energy.

2.2. Grid Side Converter

This converter keeps the voltage of DC link constant, regardless the magnitude and direction of rotor power. For this purpose a vector control approach is implemented in the simulation tool. The reference frame is oriented along the grid side voltage a decoupled power flow between the grid and converter is obtained.

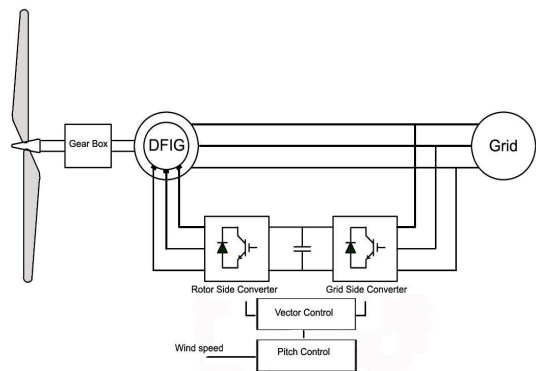

Fig.1. Variable wind speed turbine with DFIG

2.3. Rotor Side Converter

The frequency of the rotor is a function of turbine speed. The objective here is to independently control the electrical torque and the rotor excitation current. For this purpose a dq axis frame is used while oriented along stator flux vector position.

3. Control System

Based on [15] the control system components are implemented in the PSCAD/EMTDC environment. The system is equipped with a double layer control capability. The inner layer controls the electrical while the outer controls the mechanical dynamics. At lower wind speed the pitch angle is kept constant and generator torque control aims at optimum tip speed ratio λ_{opt} . For wind speed higher than nominal pitch control is necessary for the mean rated rpm of rotor and generator torque control aims at smooth output power.

3.1. Control of Grid Side Converter

Grid side converter is shown in Fig.2.

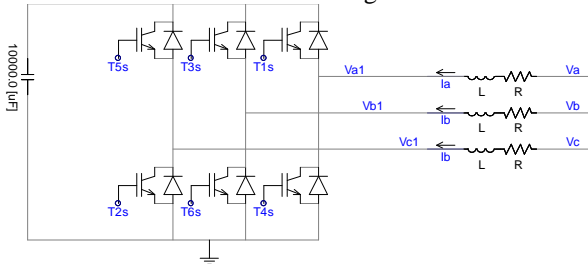

Fig.2. Grid side converter

The voltages across the inductors are:

$$\begin{bmatrix} v_a \\ v_b \\ v_c \end{bmatrix} = R \begin{bmatrix} i_a \\ i_b \\ i_c \end{bmatrix} + L \frac{d}{dt} \begin{bmatrix} i_a \\ i_b \\ i_c \end{bmatrix} + \begin{bmatrix} v_{a1} \\ v_{b1} \\ v_{c1} \end{bmatrix} \quad (1)$$

Using dq transformation on the equation 2:

$$\begin{aligned} v_d &= R i_d + L \frac{d i_d}{dt} - \omega_e L i_q + v_d \\ v_q &= R i_q + L \frac{d i_q}{dt} + \omega_e L i_d + v_q \end{aligned} \quad (2)$$

The active and reactive power flow is:

$$\begin{aligned} P &= 3(v_d i_d + v_q i_q) \\ Q &= 3(v_d i_q - v_q i_d) \end{aligned} \quad (3)$$

The angular position of grid voltage is:

$$\theta_e = \int \omega_e dt = \tan^{-1} \frac{v_\alpha}{v_\beta} \quad (4)$$

Where v_α and v_β are the voltage components of stationary 2 axis reference frame. The firing pulses of the grid side converter are obtained on the basis of the above equations and using a conventional SIN-PWM. The main block diagram for the stator side converter and its decoupled P-Q controller is shown in Figure 3.

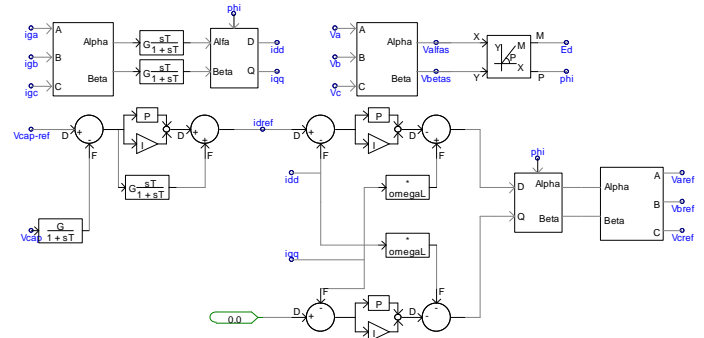

Fig.3. Main block diagram of grid side converter

3.2. Control of rotor side converter

The relation between stator voltage and rotor flux can be written as:

$$v_{sa} - R_s i_{sa} = d \frac{\lambda_{sa}}{dt} \quad (5)$$

Measuring voltages and using Clarke transformation, the position of rotor flux can be obtained from:

$$\begin{aligned} \lambda_{\alpha s} &= \int (v_{\alpha s} - R_s i_{\alpha s}) dt \\ \lambda_{\beta s} &= \int (v_{\beta s} - R_s i_{\beta s}) dt \\ \theta_s &= \tan^{-1} \frac{\lambda_{\beta s}}{\lambda_{\alpha s}} \end{aligned} \quad (6)$$

Using an inverse dq transformation and knowing the flux vector position the reference currents can be obtained. A conventional current controlled PWM then can be used to acquire firing pulses of the rotor side converter. The block diagram for the rotor side converter is shown in Figure 4.

4. Simulation Results

The performance of DFIG and its controllers has been studied in 3 different operation conditions including different wind conditions, 3-phase network fault and grid reactive power control. The simulation results which were most of interest are presented in this paper. The pitch angle in all the simulation was chosen to observe the performance of the control systems. The overall circuit diagram is shown in Figure 5.

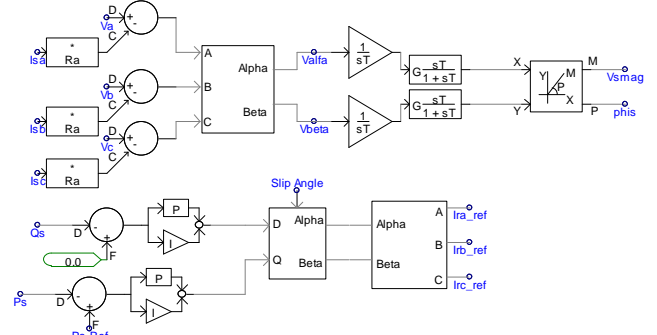

Fig.4. Main block diagram of rotor side converter

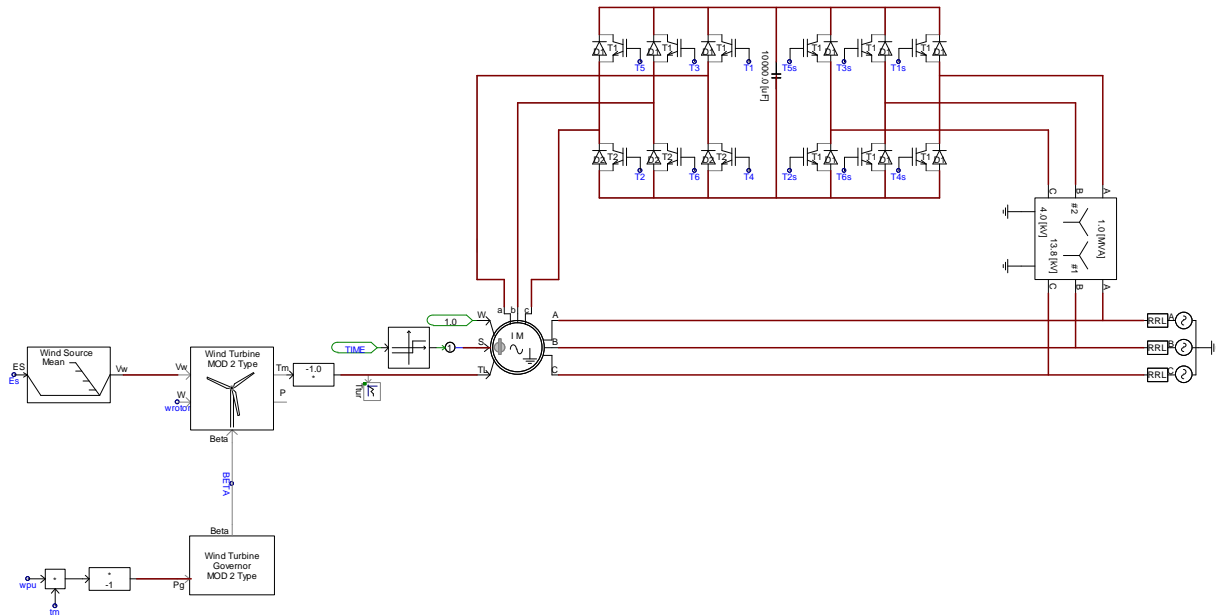

Fig.5. Wind source, wind turbine –governor and DFIG

4.1. Wind Speed is Above Nominal Speed

In Figures 6-11 the control systems responses are shown to this condition. The blades pitch angle is increased from initial 15 deg. up to 27 deg. to control the rotor speed. The variation of pitch angle is shown in Figure 6. After the rotor speed is decreased to reach about the desired power, Figure 7, the operation of DFIG will be at the active power set point and zero power factor, as shown in Figures 8-9. The DC voltage of grid side converter is also kept constant by means of its control system, Figure 10-11.

4.2. Wind Speed with Gust Component

As a result of gust components in wind speed, beginning from 4th second, there are some fluctuations in rotor speed, as shown in Figures 12-15. The pitch angle reaches its optimum value after a transient. The active and reactive powers remain at their set points.

4.3. Wind Speed with Ramp Component

Data for the ramp components is given in table 1. The responses of control are shown in figures 16-18. As the pitch angle approaches to its optimum value, its responses to the ramp components are clearly shown in these figures. The active power output is kept almost constant despite of the ramp components the variation of rotor speed.

Table.1. wind ramp data

Ramp Maximum Velocity	2 m/s
Ramp Period	1 s
Ramp Start Time	4 s
Number of Ramps	2

4.4. Wind Speed with Noise Component

The default data of PSCAD is used for the noise component and is given in table 2. The simulation results are shown in Figures 19-20. Noise components

in the wind as in reality, has the worst effect on the performance of the DFIG. The active power has the most fluctuations among different conditions of wind.

Table.2. wind gust data

Noise Amplitude Controlling Parameter	1rad/s
Surface Drag Coefficient	0.0192
Number of Noise Components	20
Turbulence Scale	600m
Random seed Number	8
Time interval for random generation	0.35s

4.5. Three Phase Fault at Grid Side

Figures 21-23 show the response of the DFIG to a three phase fault at 6th second. Figure 21-a, shows the rotor current during short circuit when the DFIG is connected to the grid through a line with high impedance. In Figure 21-b the rotor current is shown when the impedance of the line is low or the grid has a high short circuit level. The current of stator is also shown in Figure 22. The voltage of capacitor during fault is shown in Figure 23. As it was expected, the simulation results show the difficulties involved when connecting the wind turbine to a weak grid.

4.6. Reactive Power Control of DFIG

The reactive power control of networks with DG units is necessary not only for controlling the voltage profile but also for acquiring the desired active power from the DG units. The reactive power of DFIG can be controlled by desired set point of the grid side. Figure 24 shows a varying reactive power; in fact the “zero” set point of Figure 3 is used to control the reactive power according to grid side demands. As shown in Figure 25 the active power is kept constant during the reactive power variation. If the system is intended to operate in reactive power control mode it will be necessary to over rate the power electronic converter



by some extent. If this feature is used to absorb the reactive power, the amount of installed DG units can be increased with a controlled voltage profile. This operating mode can also be used to reactive power generation as shown in Figure 24. The role of DFIG, as a source of multifunctional device, recently is gaining more attention in the literature [17, 18 and 21].

4.7. Grid Frequency Support

Like the most renewable energy sources, variable speed WECS is working at its maximum power production. So the duration of frequency support of DFIG can only last for a few seconds in the cost of decreasing the rotor speed from its optimum value and decreasing power. Additional controllers are needed for the short term frequency support of DFIG as discussed in [19, 20]. If the system is intended to operate in a frequency control mode, the simplest method can be operating in a non-optimum power. When the wind speed is below the nominal, this can be achieved by operating at non optimum tip speed ratio. When the wind speed is above the nominal, decreasing the pitch angle will increase the delivered power to the grid at the cost of increasing mechanical stress. Figures 26-28 show the performance of DFIG in the described situations. As the simulation results show and noticing the rotor and stator currents in these conditions the duration of these operating states has to be kept as short as possible due to electrical and mechanical stresses.

5. Conclusion

It is expected that a significant part of wind power will be used in the form of DG in the distribution networks. Unlike the conventional power sources with a steady running prime mover, any type of renewable energy has an unsteady nature. The variety of technologies

used in renewable energy conversion makes it necessary to acquire a comprehensive knowledge of the performance of the relevant technology. In this paper a review, modeling and simulation of WECS including DFIG is presented. It is shown that more flexible types of DFIG will meet the requirement of renewable energy conversion systems. On the other hand using DFIG will improve the efficiency of the power conversion and provides a flexible DG to interact with the distribution systems including DG wind generation is studied. Above the nominal wind speed, pitch angle is used to control the mechanical power. The DFIG is also has a flexible performance during wind gusts. During transient conditions it has an acceptable performance, nevertheless it is necessary to study auxiliary controls in a sever fault condition. DFIG can operate at zero power factors and it is also possible to set a reactive power factor set point according to the distribution network condition. The role of DFIG as a multifunctional device and power conditioner is also expected to rise. More likely DFIG will be used as a Renewable Flexible Distributed Generation (RFDG) device. Further studies are required to investigate the performance of DFIG, using more realistic models of distribution grid. A configuration of multiple DFIGs including the detailed models, connected to the distribution grid is also necessary to study the overall performance of distribution grids with DGs. Another application could be when it is possible to operate DFIG by a permanent prime mover rather than wind power. In this case where the variable speed capability of DFIG is not required it can be used as a compensator or power conditioner.

6. Simulation Figures

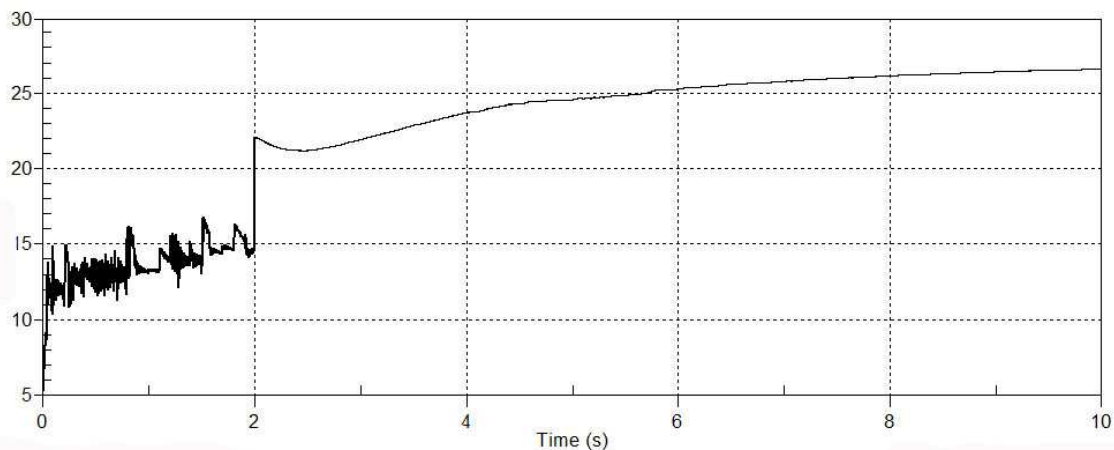

Fig.6. Pitch angle (Degree)

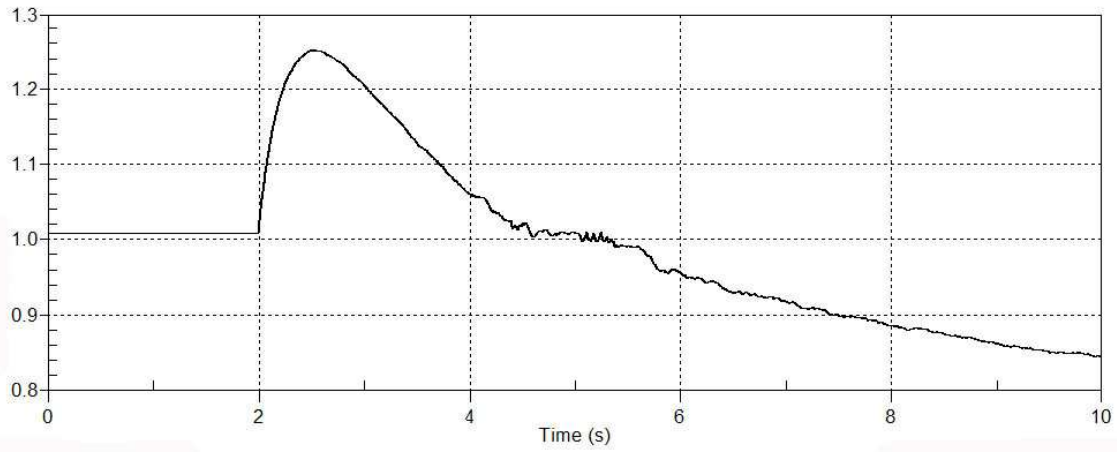

Fig.7. Rotor speed (pu)

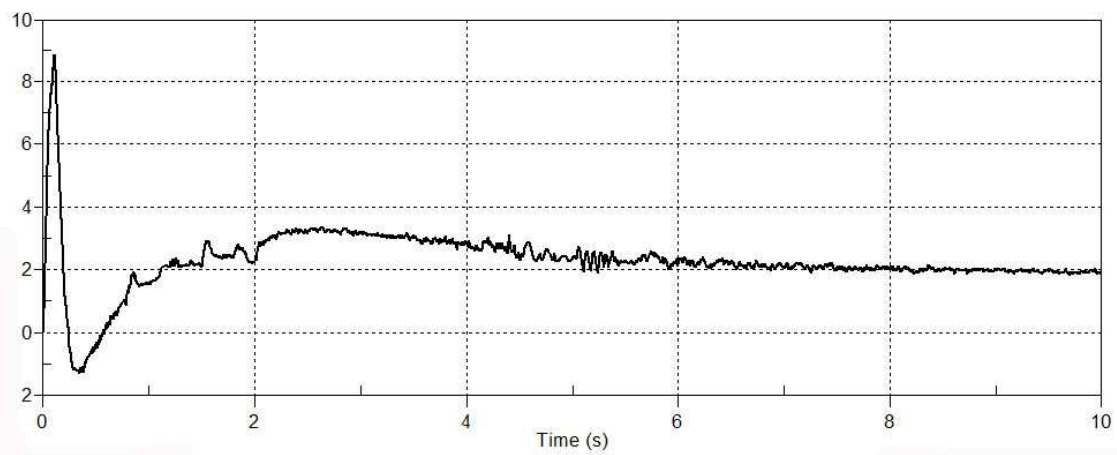

Fig.8 Active power output (MW)

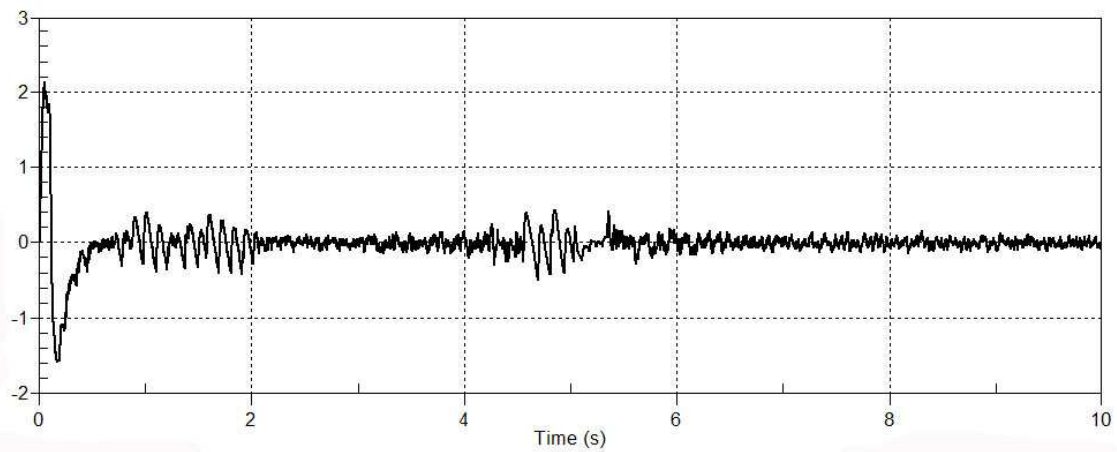

Fig.9 Reactive output power (MVar)



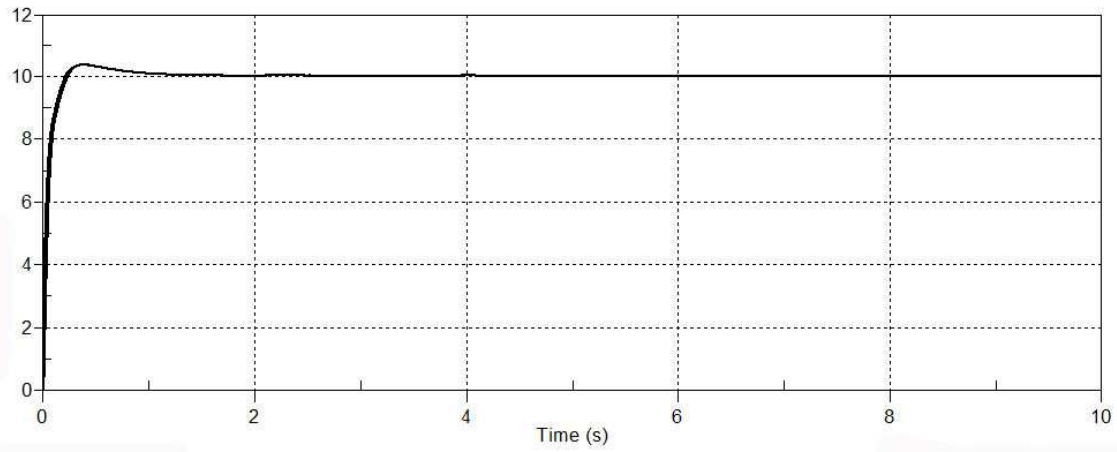

Fig.10. Capacitor DC voltage (KV)

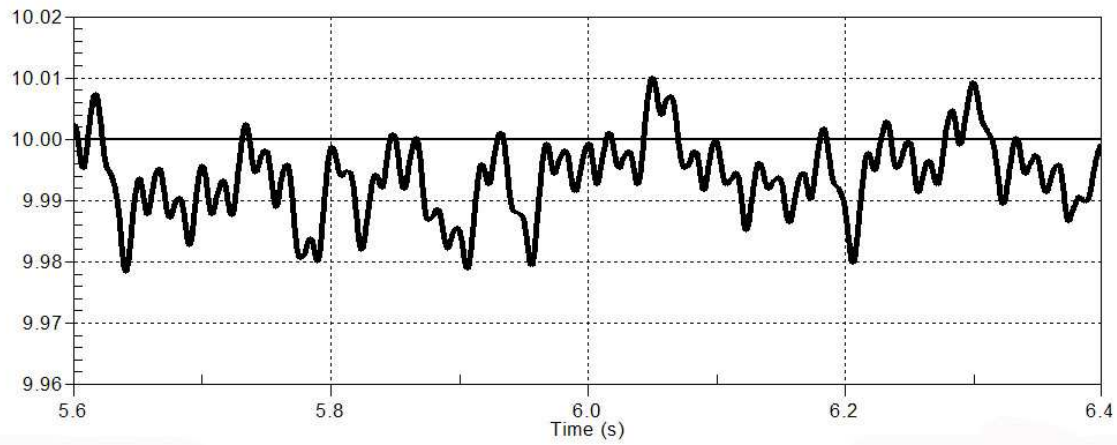

Fig.11. Capacitor DC voltage (KV)

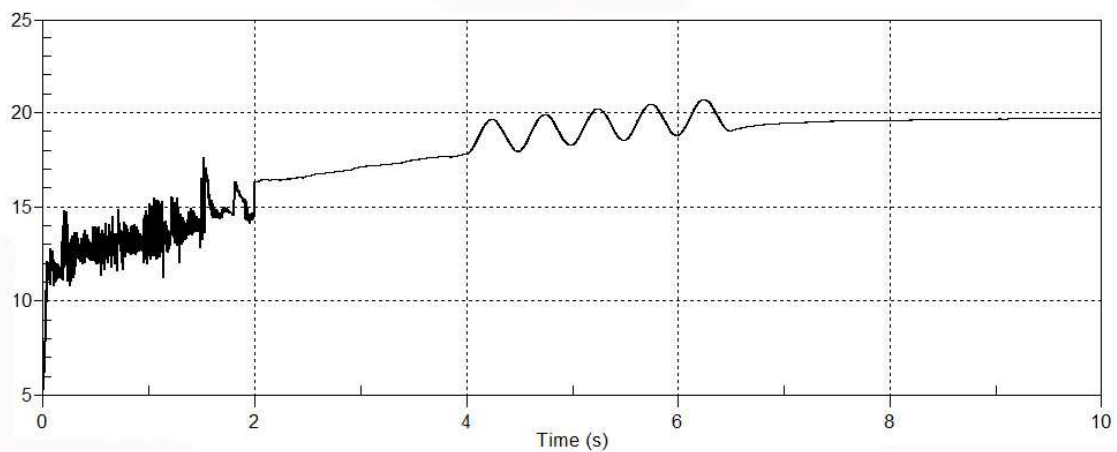

Fig.12. Pitch angle (Degree) - gust component

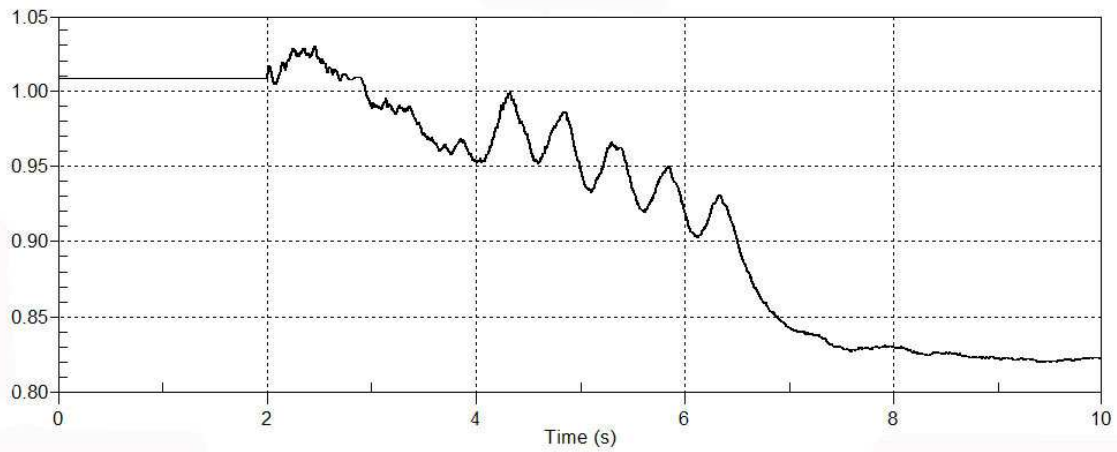

Fig.13. Rotor speed (pu) - Gust component

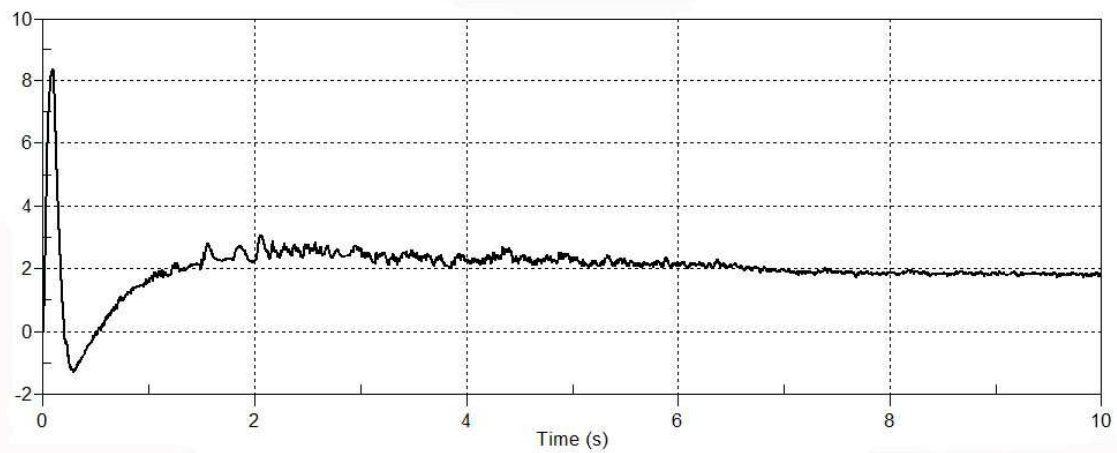

Fig.14. Active power output (MW) - Gust component

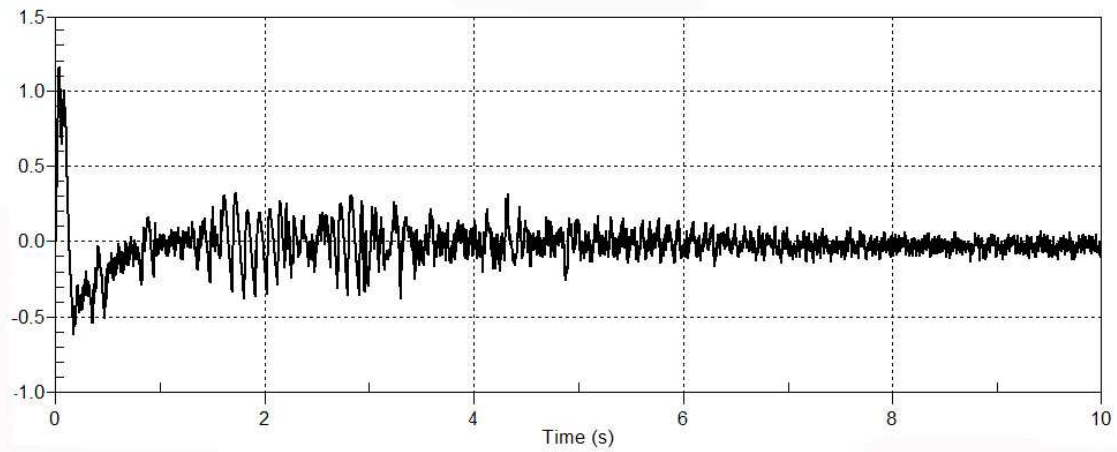

Fig.15. Reactive output power (MVar) - Gust component



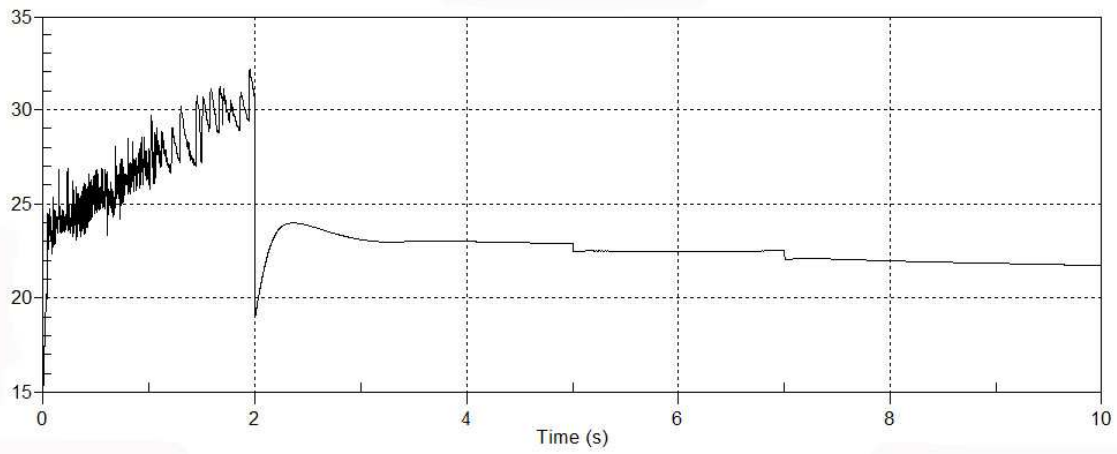

Fig.16. Pitch angle (Degree) - ramp component

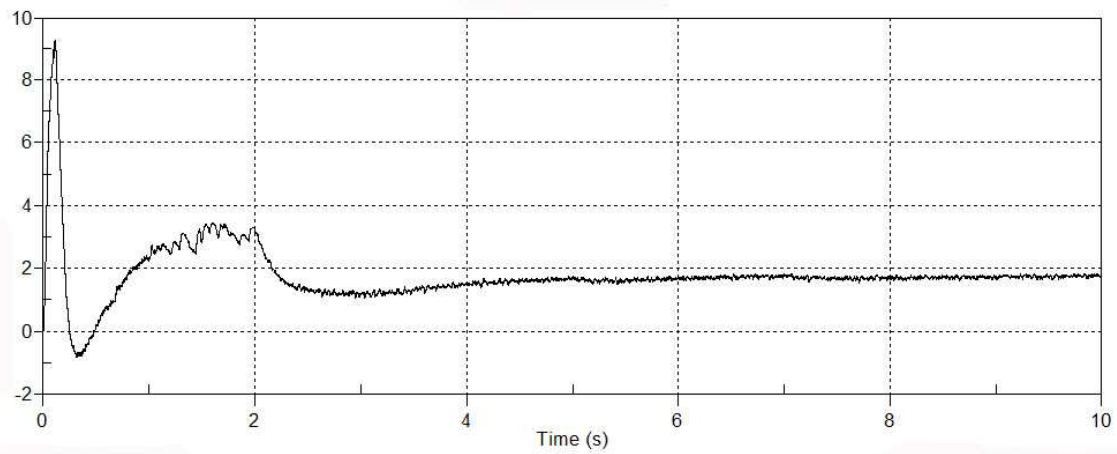

Fig.17. Active power output (MW) - ramp component

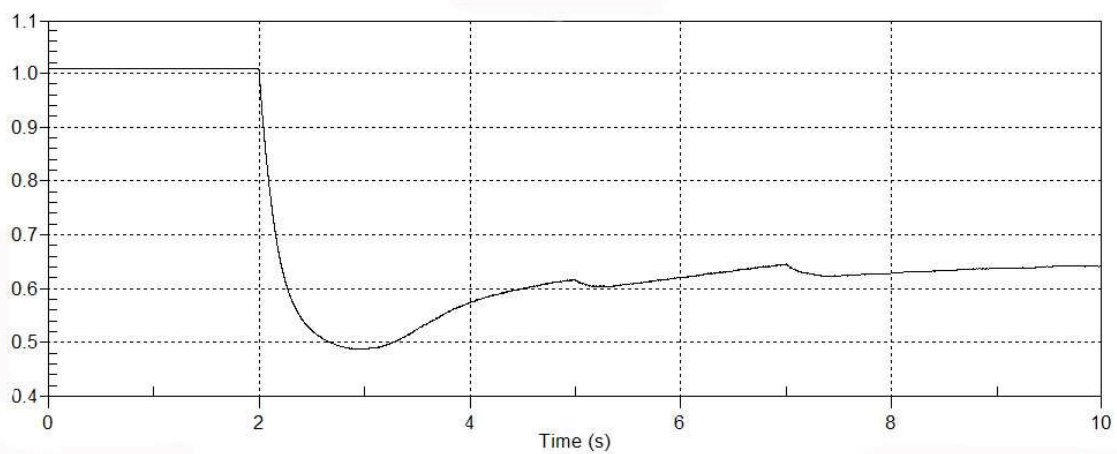

Fig.18. Rotor speed (pu) - ramp component

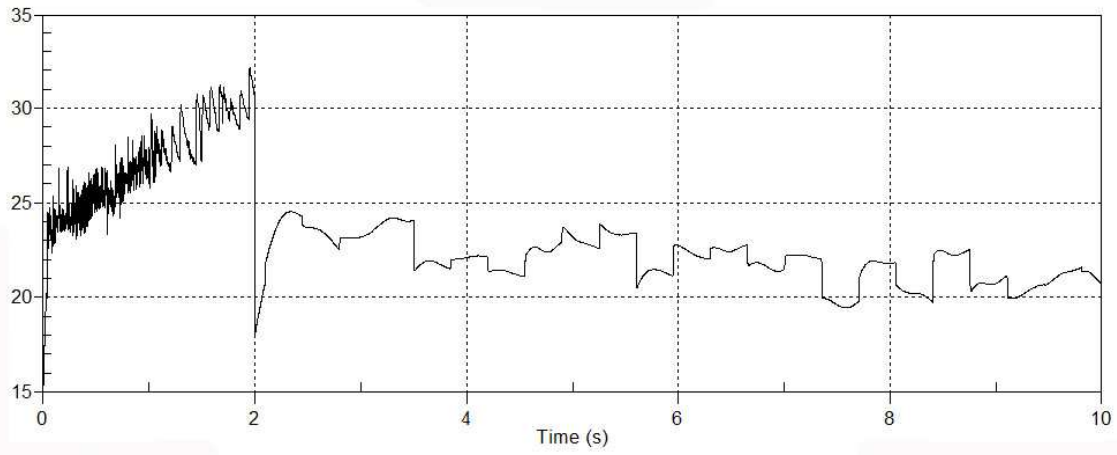

Fig.19. Pitch angle (Degree) - noise component

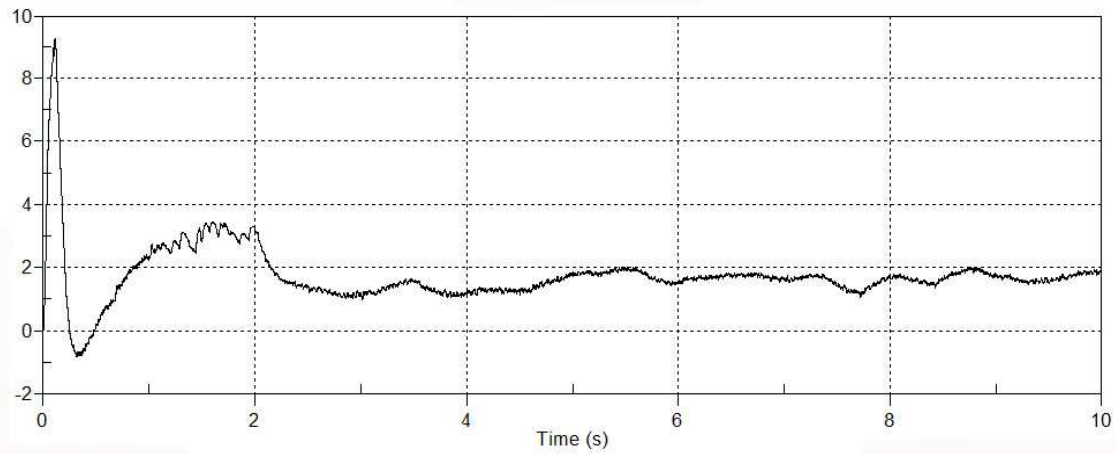

Fig.20. Active power output (MW) - noise component

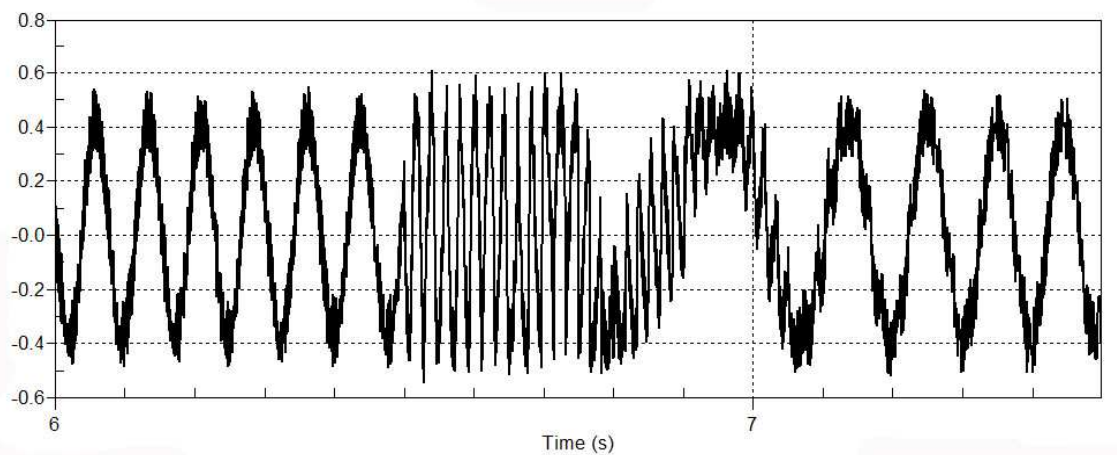

Fig.21-a. Rotor current (kA) - three phase fault

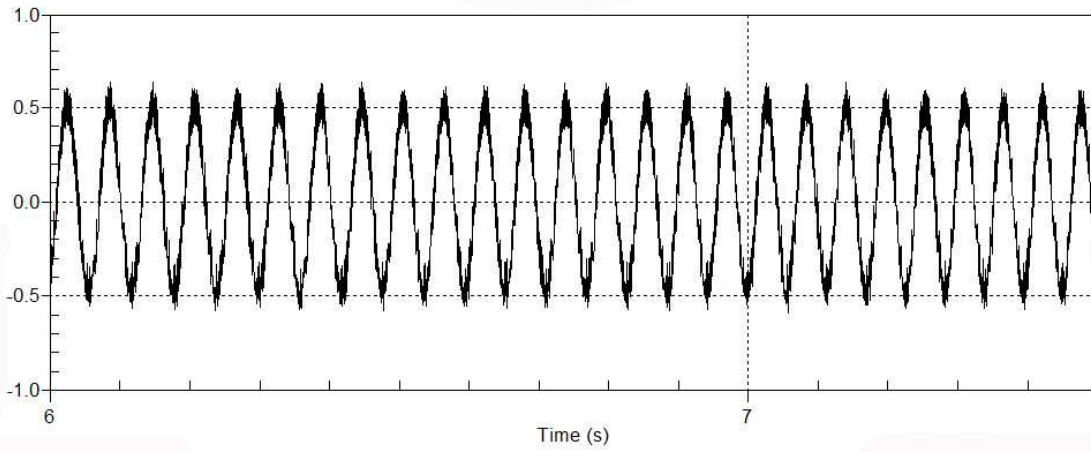

Fig.21-b. Rotor current (kA) - three phase fault

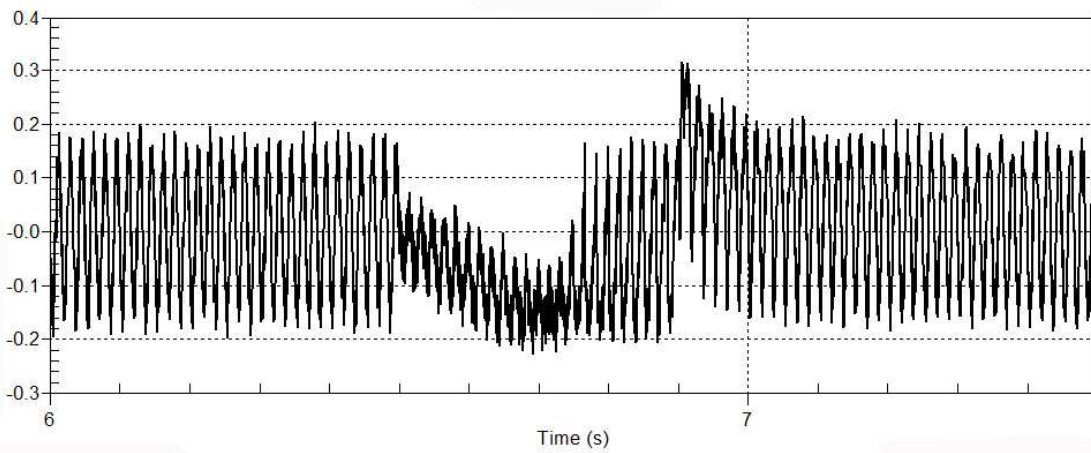

Fig.22. Stator current (kA) - three phase fault

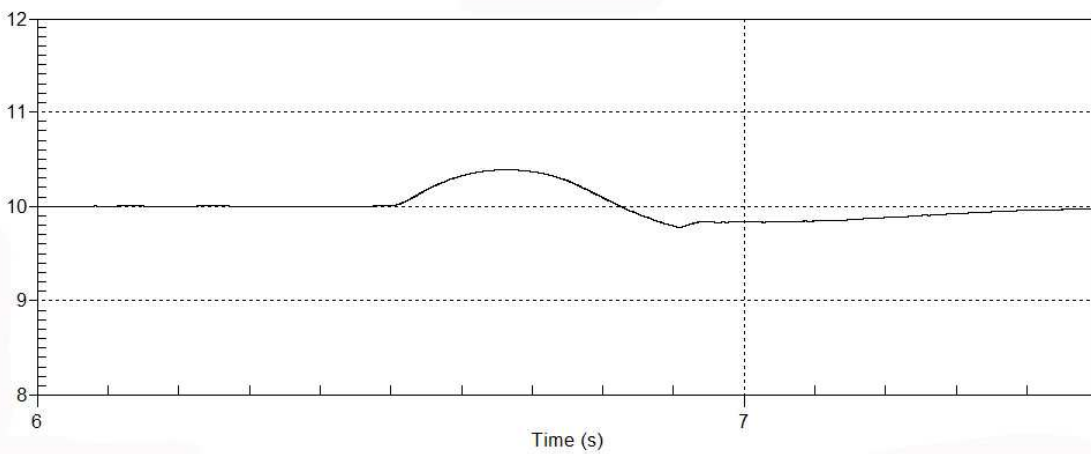

Fig.23. Capacitor DC voltage (KV) - three phase fault

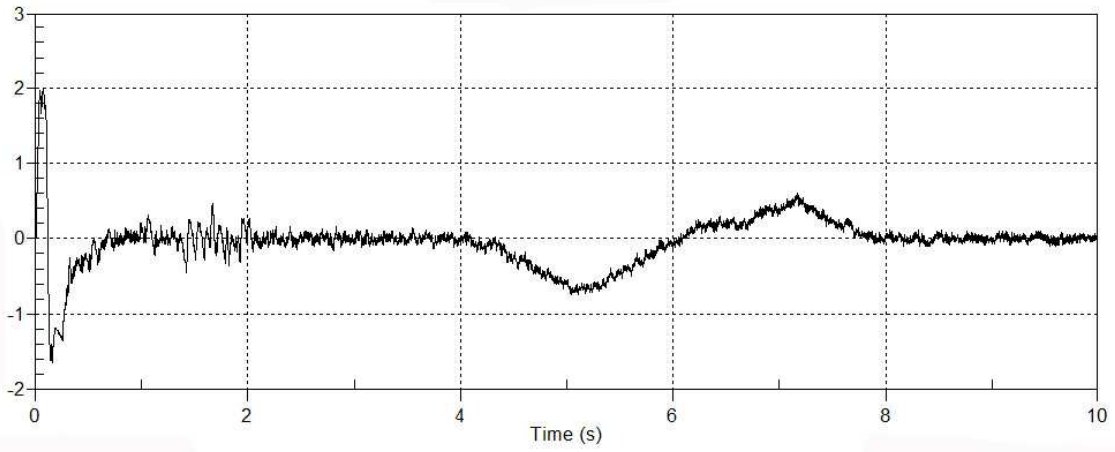

Fig.24. Reactive power output (MW) - reactive power control

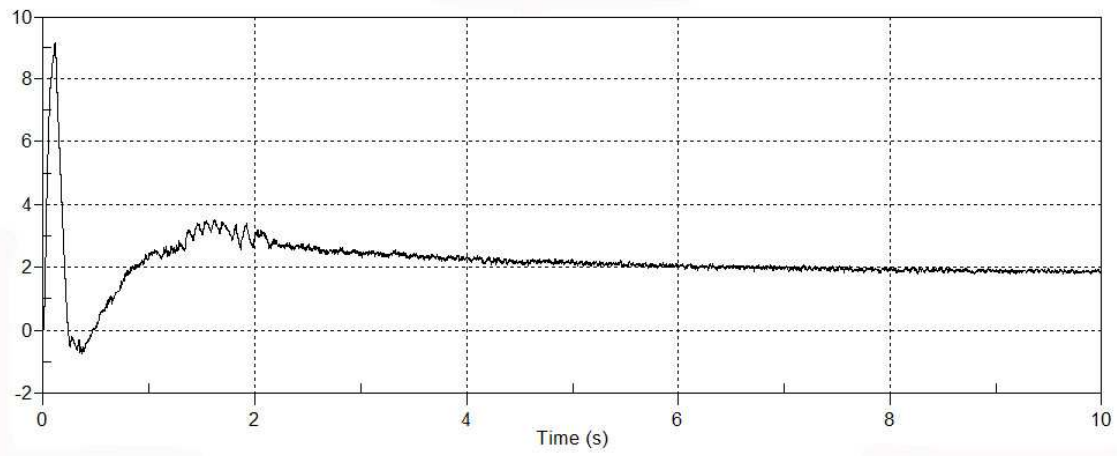

Fig.25. Active power output (MW) - Reactive power control

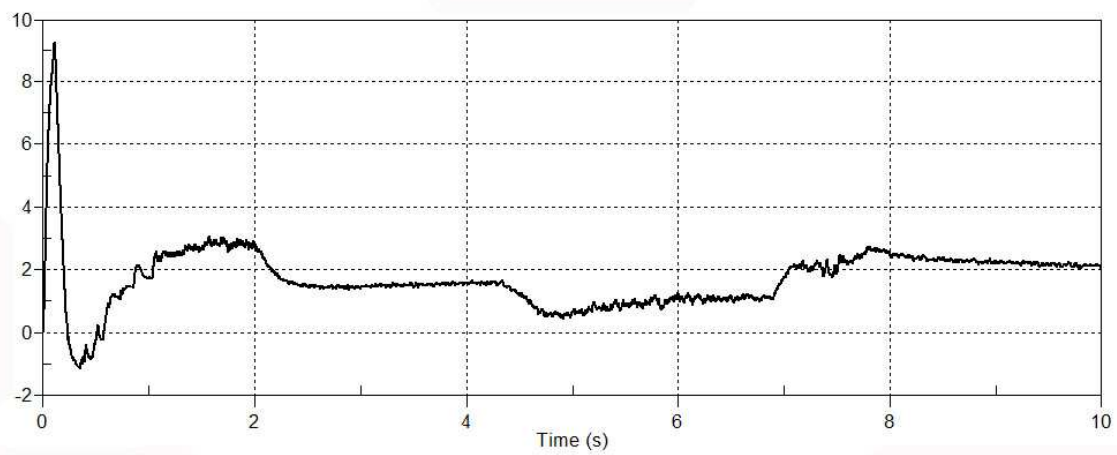

Fig.26. Active power output (MW) - active power control



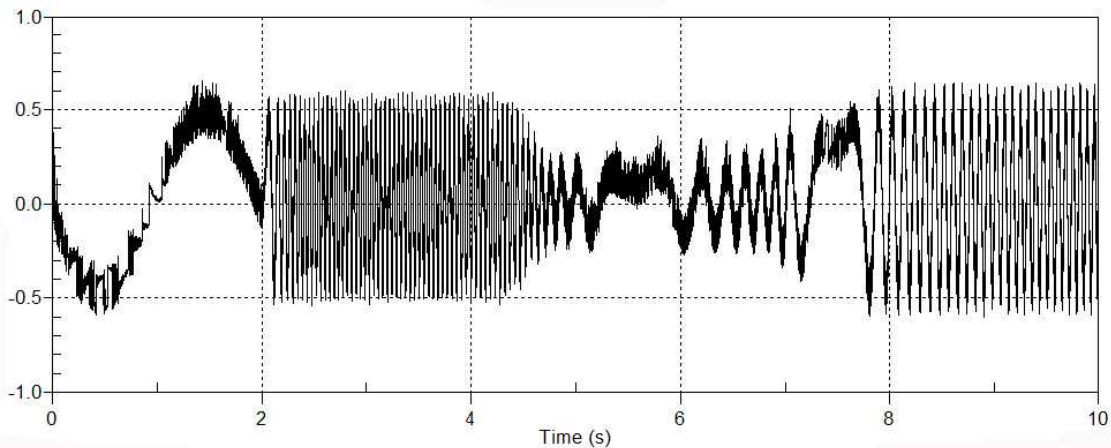

Fig.27. Rotor current (kA) - active power control

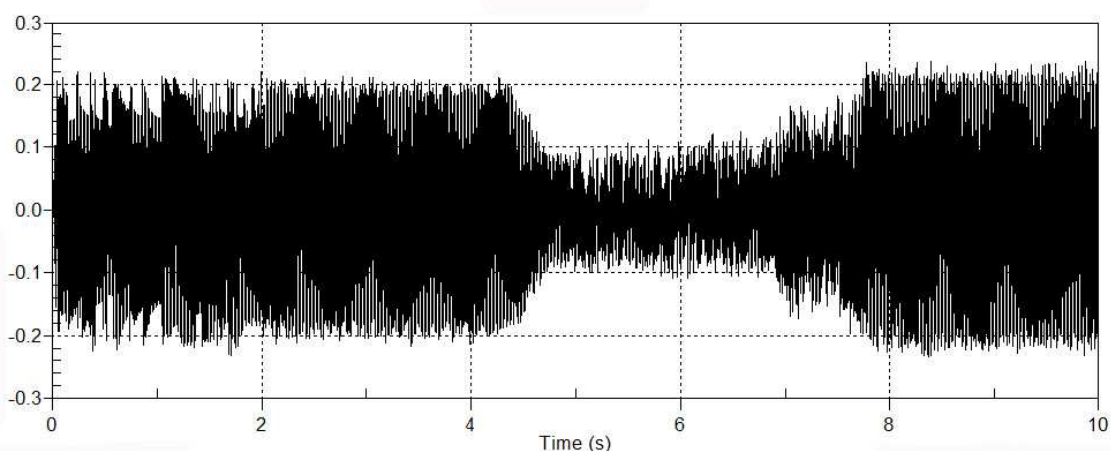

Fig.28. Stator current (kA) - active power control

References

- [1] T. Ackermann, G. Andersson, L. Soder: Distributed generation: a definition, *Electric Power Systems Research* 57 (2001) 195–204 ELSEVIER
- [2] R. Lawrence, S. Middlekauff: The New Guy on the Block, *IEEE Industry Application magazine*, Jan 2005.
- [3] W. El-Khattam, M.M.A. Salama: Distributed generation technologies, definitions and benefits, *Electric Power Systems Research* 71 (2004) 119–128, ELSEVIER
- [4] G. Pepermans, et al: Distributed generation: definition, benefits and issues, *Energy Policy* 33 (2005) 787–798 ELSEVIER
- [5] R. Ramakumar, P. Chiradeja: Distributed Generation and Renewable Energy Systems, *Energy Conversion Engineering Conference*, 2002. IECEC apos;02. 2002 37th Intersociety, Volume, Issue, 29-31 July 2004
- [6] L.Kojovic: Modeling Requirements to Study Interactions of DG and Distribution Systems, *Power Engineering Society Summer Meeting*, 2002 IEEE, Volume 1, Issue , 25-25 July 2002 Page(s):447 - 448 vol.1
- [7] B. Delfino: Modeling of the Integration of Distributed Generation into the Electrical System: *Power Engineering Society Summer Meeting*, 2002 IEEE, 25-25 July 2002, Volume: 1, page(s): 170-175 vol.1
- [8] L.H. Hansen et al: Conceptual survey of generators and power electronics for wind turbines. *Riso National Laboratory*, December 2001
- [9] J.F Manwell. et al.: *Wind Energy Explained*, John Wiley & Sons, England, 2002
- [10] T. Burton et al: *Wind Energy Handbook*, John Wiley & Sons, England, 2001
- [11] T. Ackermann *Wind Power in Power Systems*, John Wiley & Sons, England, 2005
- [12] R. Gasch, J.Twlele, *Wind Power Plants Fundamentals, Design, Construction and Operation*, Solarpraxis, Berlin, 2002
- [13] F. Blaabjerg, Zhe Chen, S.B Kjaer,., *Power electronics as efficient interface in dispersed power generation systems*, *IEEE Transactions on Power Electronics*, Vol. 19, Issue: 5, pp.1184-1194, .Sept. 2004
- [14] J.M Carrasco,., et al, *Power-Electronic Systems for the Grid Integration of Renewable Energy Sources: A Survey*, *IEEE Transactions on*

Industrial Electronics, Vol. 53, Issue 4, pp 1002-106, June 2006

- [15] R. Pena, J.C. Clare and G.M. Asher, "Doubly fed induction generator using back to back PWM converters and its application to variable speed wind energy generation", IEE Proc. Electrical Power Applications, Vol. 143., No.3., May 1996.
- [16] R.J Koessler, S Pillutla, L.H Trinh, D.L Dickmader, *Integration of large wind farms into utility grids pt. 1 - Modeling of DFIG*, Power Engineering Society General Meeting, Volume: 3, pp.1519, July 2003
- [17] Hee-Sang Ko, Gi-Gab Yoon, and Won-Pyo Hong, "Active Use of DFIG-Based Variable-Speed Wind-Turbine for Voltage Regulation at a Remote Location", IEEE TRANSACTIONS ON POWER SYSTEMS, VOL. 22, NO. 4, NOVEMBER 2007
- [18] Hee-Sang Ko, Sylvain Bruey, Juri Jatskevich, Guy Dumont, and Ali Moshref, "A PI Control of DFIG-Based Wind Farm for Voltage Regulation at Remote Location", Power Engineering Society General Meeting, 2007. IEEE, 24-28 June 2007 Page(s):1 – 6
- [19] F. Michael Hughes, Olimpo Anaya-Lara , Nicholas Jenkins, and Goran Strbac, "A Power System Stabilizer for DFIG-Based Wind Generation", IEEE TRANSACTIONS ON POWER SYSTEMS, VOL. 21, NO. 2, MAY 2006.
- [20] O. Anaya-Lara, F.M. Hughes, N. Jenkins and G. Strbac, "Contribution of DFIG-based wind farms to power system short-term frequency regulation", IEE Proc.-Gener. Transm. Distrib., Vol. 153, No. 2, March 2006.

[21] احمد صالحی دویخشری، محمود فتوحی فیروزآباد "برنامه‌ریزی توسعه واحدهای تولیدی در حضور نیروگاه‌های بادی از نقطه نظر قابلیت اطمینان" مجله انجمن مهندسين برق و الكترونيك ايران، سال پنجم، شماره اول، بهار و تابستان ۸۷

